



**ABAX
KINGFISHER**



LORD

PRODUCT DATA SPECIFICATION

Lord Pod Chair

Description	
DIMENSIONS / FABRIC METERAGE	Overall Dimensions: 635mmW x 610mmD x 800mmH Seat Height: 470mmH Fabric Meterage: 2.4m
MATERIALS & CONSTRUCTION	The shell consists of plywood, filled with high resilience sponge, feather and polyester staple and finished in upholstery The frame is constructed from aluminium alloy
ADJUSTMENT	N/A
FEATURES	Secure aluminium frame Embodies the minimalist aesthetics, where the space design emphasises on extreme leisure and comfort Unique design
WARRANTY	10 years
LEAD TIME	12-16 Weeks
FINISH	Shell Finish Fabric Grade A, B, C, D or E Frame Finish Polished Aluminium Alloy
CUSTOMISABLE	N/A
ACCESSORIES	N/A

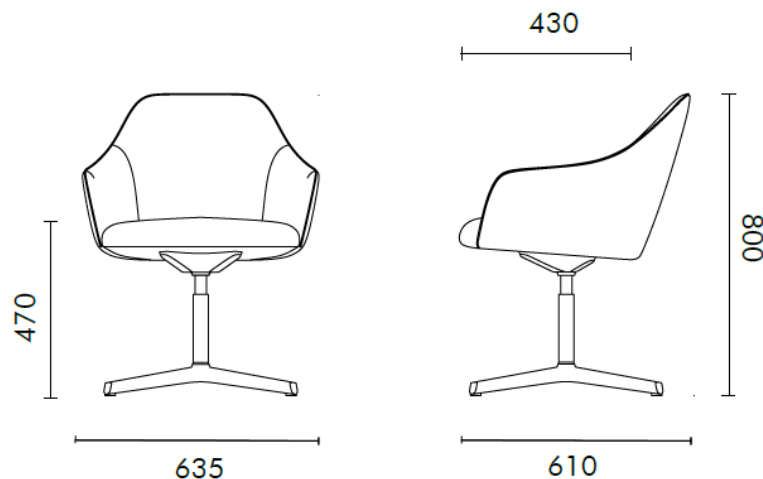

Fabric Colour Swatches

OTE Sunday

A

Composition	100% Polyester
Origin	China
Abrasion	≥ 40000
Lightfastness	
Rubbing	4.5
Pilling	4



Sunday 10



Sunday 34



Sunday 39



Sunday 53



Sunday 83



Sunday 103



Sunday 149



Sunday 02



Sunday 27



Sunday 22



Sunday 80

OTE Vico

A

Composition 93% Polyester,
5% Cotton, 2% Nylon
Origin China
Abrasion \geq 40000
Lightfastness 4
Rubbing 4
Pilling 4



vico-04



vico 08



vico 09



vico 11



vico 20

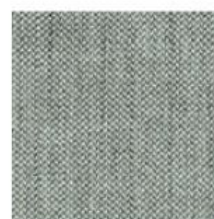

vico 33



vico 41



vico 47



vico 64

OTE Decent

A

Composition 100% Polyester
Origin China
Abrasion \geq 40000
Lightfastness 4
Rubbing 4
Pilling



Decent 02



Decent 09



Decent 10



Decent 15



Decent 21

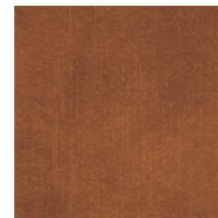

Decent 26



Decent 29

Hafeele LE9140B

B

Composition 100% Polyester
Origin China
Abrasion
Lightfastness 4
Rubbing 4-5
Pilling



LE9140B-01



LE9140B-02



LE9140B-16



LE9140B-27



LE9140B-33



LE9140B-35



LE9140B-38

Gabriel Medley

B

Composition 100% Polyester
Origin Denmark
Abrasion ≥ 75000
Lightfastness 5-7
Rubbing 4-5
Pilling 4



GM-60004

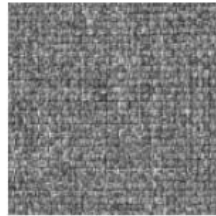

GM-60167



GM-61002



GM-61003



GM-62002



GM-63017



GM-63064



GM-66007



GM-66010



GM-66145



GM-67053



GM-68002



GM-68005

Novatex

B

Composition 79% Polyester, 13%
Acrylic, 8% Viscosa
Origin China
Abrasion ≥ 20000
Lightfastness
Rubbing 4-4.5
Pilling



NA 05



NA 14

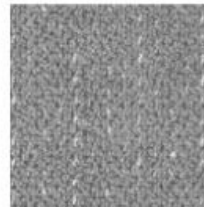

NA 18

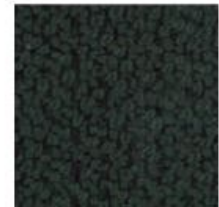

NA 62

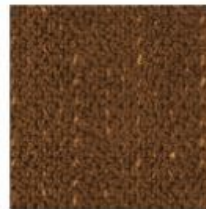

NA 71

MAYA

B

Composition 54% Polyester,
46% Acrylic
Origin China
Abrasion ≥ 25000
Lightfastness
Rubbing 3-4
Pilling



A2267-2A



A2267-3A

Sunbrella

C

Composition
Origin USA
Abrasion

Lightfastness 4-5
Rubbing
Pilling



Annex Cobalt 44267-0004



Annex Guava 44267-0006



Draft Classic 145408-0001



Tropics Jungle 145214-0000

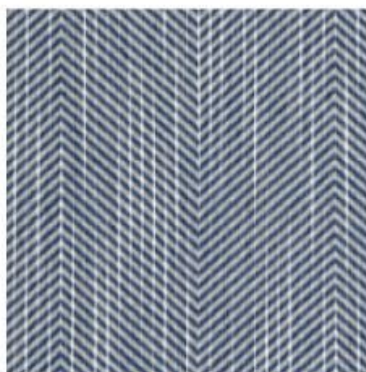

Annex Cobalt 44267-0004

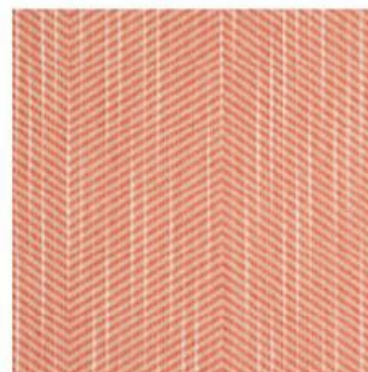

Annex Guava 44267-0006



Draft Classic 145408-0001



Tropics Jungle 145214-0000

Camira Oceanic

D

Composition 100% post-consumer recycled plastic, including 50% SEAQUAL yarn
Origin UK
Abrasion ≥ 100000
Lightfastness 5
Rubbing 4
Pilling 4

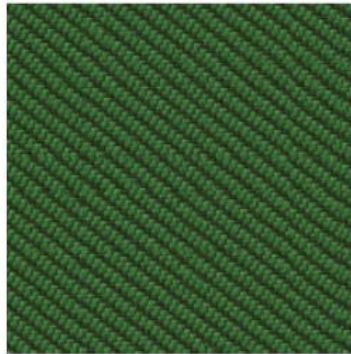

OOC03



OOC04



OOC07



OOC08



OOC10



OOC11



OOC12



OOC13



OOC15



OOC16

Camira Blazer

D

Composition	100% Pure New Wool
Origin	UK
Abrasion	≥ 50000
Lightfastness	5
Rubbing	4
Pilling	4

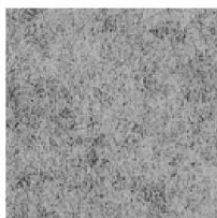

CUZ1E

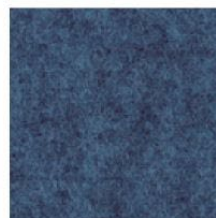

CUZ1W



CUZ30

Kvadrat Remix 3

E

Composition	90% new wool worsted 10% nylon
Origin	UK
Abrasion	≥ 100000
Lightfastness	6
Rubbing	7
Pilling	4

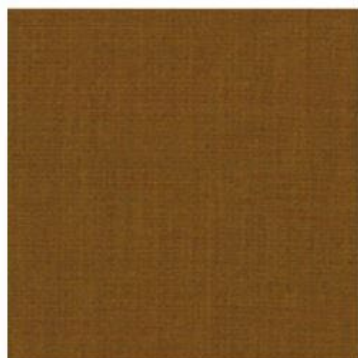

Remix 30422



Remix 30612



Remix 30632



Remix 30743



Remix 30933



Remix 30982