



**ABAX  
KINGFISHER**



**LORD**

PRODUCT DATA SPECIFICATION

## Lord Chair Timber Base

Description	
<b>DIMENSIONS / FABRIC METERAGE</b>	<b>Overall Dimensions:</b> 650mmW x 565mmD x 780mmH <b>Seat Height:</b> 450mmH <b>Fabric Meterage:</b> 2.4m
<b>MATERIALS &amp; CONSTRUCTION</b>	The shell consists of plywood, filled with high resilience sponge, feather and polyester staple and finished in high quality upholstery.  The frame is constructed from plywood and PU painted
<b>ADJUSTMENT</b>	N/A
<b>FEATURES</b>	Secure timber base  Frame is
<b>WARRANTY</b>	10 Years
<b>LEAD TIME</b>	12 – 14 Weeks
<b>FINISH</b>	<b><u>Upholstered Shell</u></b> Fabric Grade A, B, C, D or E  <b><u>Frame Finish</u></b> Dark Brown Oak Beech
<b>CUSTOMISABLE</b>	N/A
<b>ACCESSORIES</b>	Foot Rest: 640mmW x 470mmD x 390mmH

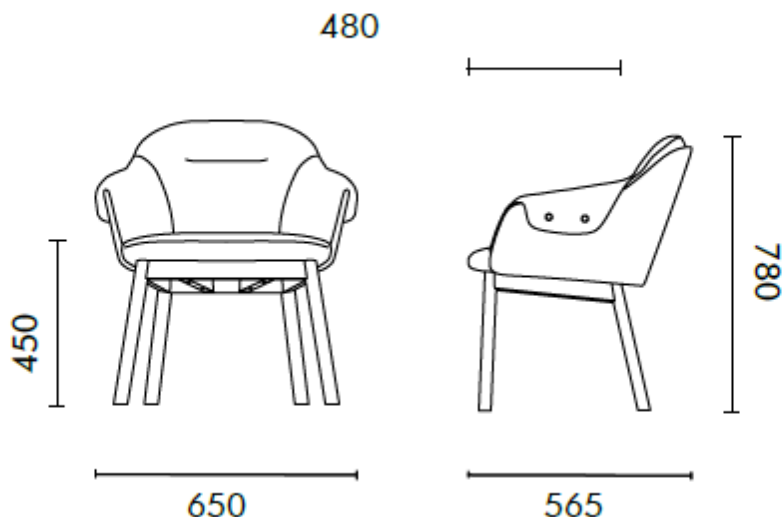

## Fabric Colour Swatches

### OTE Sunday

**A**

**Composition** 100% Polyester  
**Origin** China  
**Abrasion**  $\geq 40000$   
**Lightfastness**  
**Rubbing** 4.5  
**Pilling** 4



Sunday 10



Sunday 34



Sunday 39



Sunday 53



Sunday 83



Sunday 103



Sunday 149



Sunday 02



Sunday 27



Sunday 22



Sunday 80

## OTE Vico

A

**Composition** 93% Polyester,  
5% Cotton, 2% Nylon  
**Origin** China  
**Abrasion** ≥ 40000  
**Lightfastness** 4  
**Rubbing** 4  
**Pilling** 4



vico-04



vico 08



vico 09



vico 11



vico 20

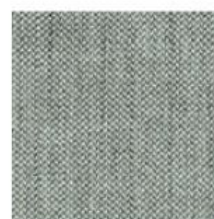

vico 33



vico 41



vico 47



vico 64



## OTE Decent

**A**

Composition 100% Polyester  
Origin China  
Abrasion  $\geq$  40000  
Lightfastness 4  
Rubbing 4  
Pilling



Decent 02



Decent 09



Decent 10



Decent 15



Decent 21

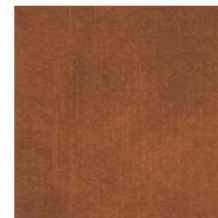

Decent 26



Decent 29

## Hafeele LE9140B

**B**

Composition 100% Polyester  
Origin China  
Abrasion  
Lightfastness 4  
Rubbing 4-5  
Pilling



LE9140B-01



LE9140B-02



LE9140B-16



LE9140B-27



LE9140B-33



LE9140B-35



LE9140B-38

## Gabriel Medley

**B**

Composition 100% Polyester  
Origin Denmark  
Abrasion  $\geq 75000$   
Lightfastness 5-7  
Rubbing 4-5  
Pilling 4



GM-60004

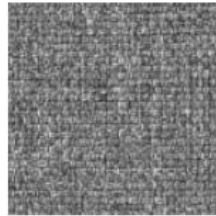

GM-60167



GM-61002



GM-61003



GM-62002



GM-63017



GM-63064



GM-66007



GM-66010



GM-66145



GM-67053



GM-68002



GM-68005

## Novatex

**B**

**Composition** 79% Polyester, 13%  
Acrylic, 8% Viscosa  
**Origin** China  
**Abrasion**  $\geq$  20000  
**Lightfastness**  
**Rubbing** 4-4.5  
**Pilling**



NA 05



NA 14

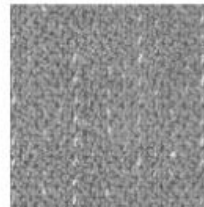

NA 18

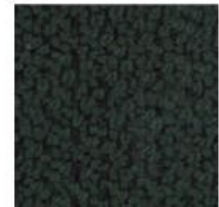

NA 62



NA 71

## MAYA

**B**

**Composition** 54% Polyester,  
46% Acrylic  
**Origin** China  
**Abrasion**  $\geq$  25000  
**Lightfastness**  
**Rubbing** 3-4  
**Pilling**



A2267-2A

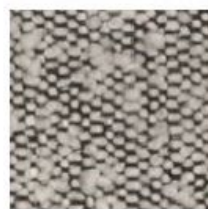

A2267-3A



## Sunbrella

C

Composition  
Origin USA  
Abrasion

Lightfastness 4-5  
Rubbing  
Pilling



Annex Cobalt 44267-0004



Annex Guava 44267-0006



Draft Classic 145408-0001



Tropics Jungle 145214-0000

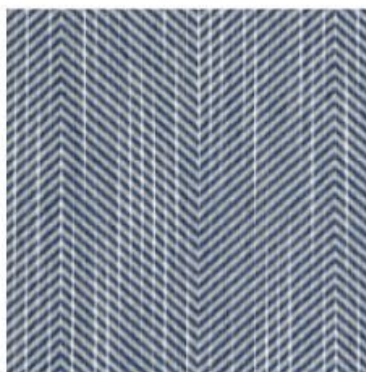

Annex Cobalt 44267-0004

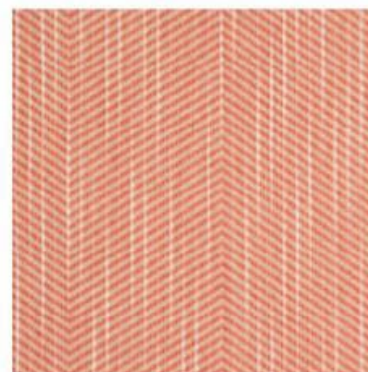

Annex Guava 44267-0006



Draft Classic 145408-0001



Tropics Jungle 145214-0000



## Camira Oceanic

**D**

**Composition** 100% post-consumer recycled plastic, including 50% SEAQUAL yarn  
**Origin** UK  
**Abrasion**  $\geq 100000$   
**Lightfastness** 5  
**Rubbing** 4  
**Pilling** 4

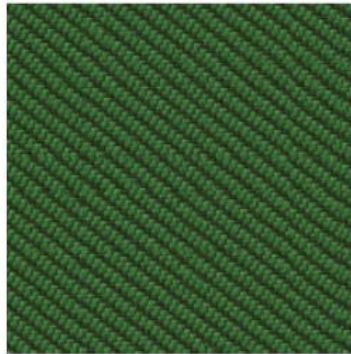

OOC03



OOC04



OOC07



OOC08



OOC10



OOC11



OOC12



OOC13



OOC15



OOC16

## Camira Blazer

D

<b>Composition</b>	100% Pure New Wool
<b>Origin</b>	UK
<b>Abrasion</b>	≥ 50000
<b>Lightfastness</b>	5
<b>Rubbing</b>	4
<b>Pilling</b>	4

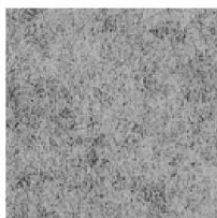

CUZ1E

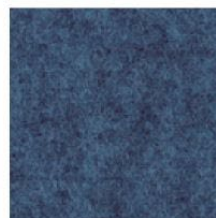

CUZ1W



CUZ30

## Kvadrat Remix 3

E

<b>Composition</b>	90% new wool worsted 10% nylon
<b>Origin</b>	UK
<b>Abrasion</b>	≥ 100000
<b>Lightfastness</b>	6
<b>Rubbing</b>	7
<b>Pilling</b>	4

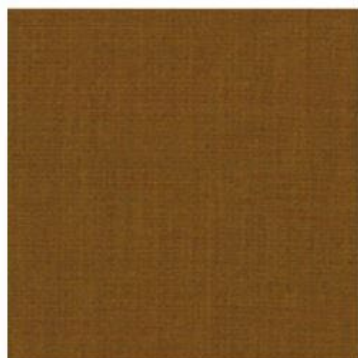

Remix 30422



Remix 30612



Remix 30632



Remix 30743



Remix 30933



Remix 30982